

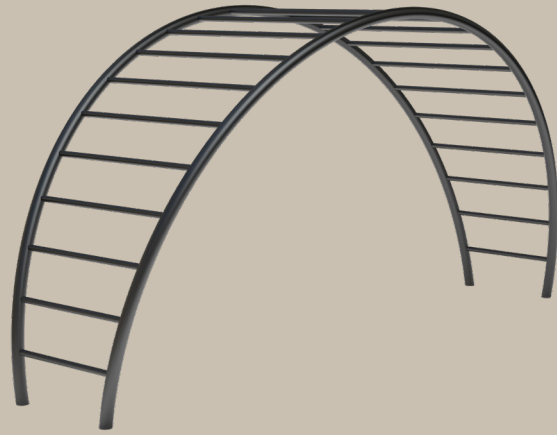

Technical data

Product no.: no-032

SPIRER ARCHED MONKEY BAR



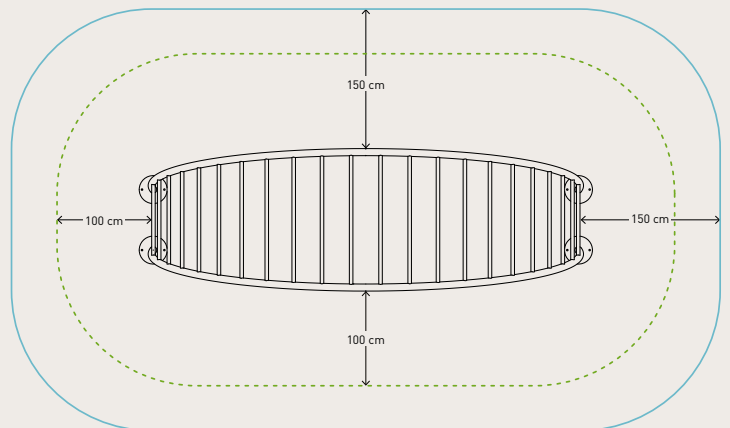
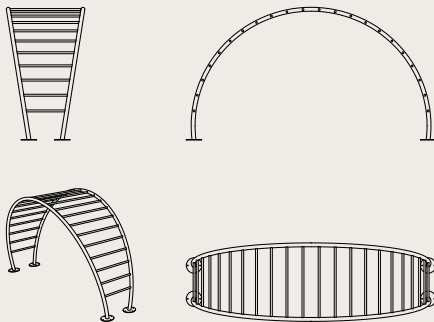

Dimension in cm: L465 x W153 x H230 cm
Material: Steel
Corrosion class: C4
Surface treatment: Rust-protected and powder-coated

Area of movement: 
Training space: 
Free height of fall: 230 cm
Fall protection required: Yes ground material as bark/sand/woodchips/gravel/rubber
According to: EN 16630:2015



Please note:

As a general rule, the green lines  are not allowed to overlap each other. However the blue lines  can overlap both the blue and the green lines, BUT there cannot be any solid or hard objects inside the blue circle. (Trees, stones, other fitness equipment, etc.)

EXERCISES / STRETCH OUT

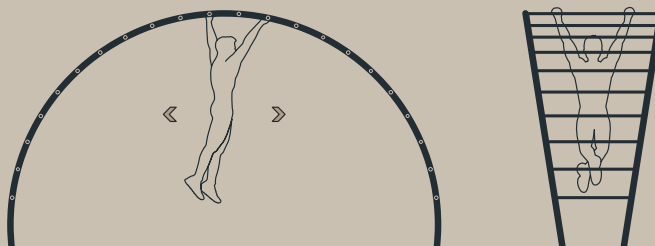

NOORD