

INSTALLATION INSTRUCTION

Spirerne

NOORD
Outdoor fitness

RECOMMENDATIONS FOR INSTALLATION

The guarantee demands that NOORD's recommendations for installation and maintenance are met.

When installing the equipment we highly recommend to follow the guidelines according to EN 16630 ("Permanently installed outdoor fitness equipment — Safety requirements and test method"), as shown below.

FOUNDATIONS

Foundations shall be designed in such a way that they do not present a hazard (e.g. tripping, impact).

In case of loose fill material (e.g. sand), foundations shall be installed or laid in accordance with one of the following:

- foundations of the equipment to which the pedestals, footings and fixings are attached shall be at least 400 mm below the ground surface or the installed depth of surfacing; or

Note: This does not include the socket of post shoes or similar which a continuation of the attached post.

- the top of the foundations shall be at least 200 mm below the ground surface, as shown in the example below; or
- foundations shall be covered by pieces of equipment or equipment parts; or
- foundations shall be formed by above ground support shoes.

Any parts protruding from the foundations (e.g. ends of screws) shall be at least 400 mm below the ground surface, unless they are effectively covered.

Example of Foundations

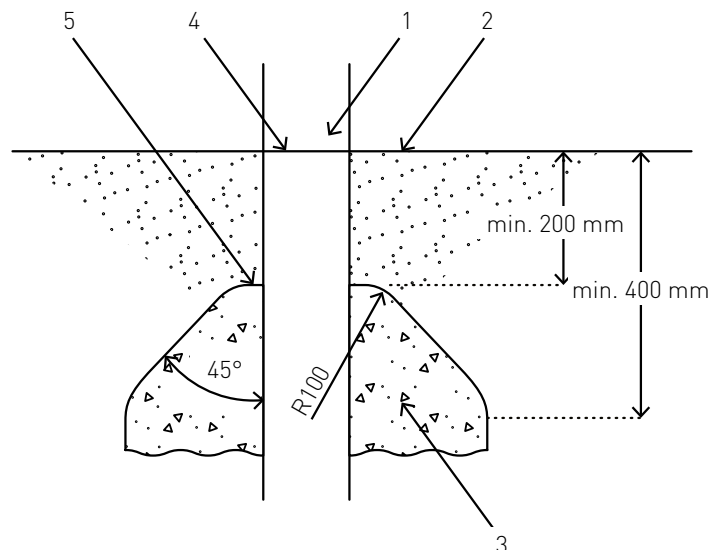



Dimensions in millimetre

KEY

- Post
- Ground surface
- Foundation
- Basic level mark
- Top of foundation

GUIDELINES FOR DISTANCE BETWEEN TRAINING SPACE AND AREA OF MOVEMENT

As a general rule, the green dotted lines  are not allowed to overlap each other. However the solid blue lines  can overlap both the blue and the green lines, BUT there cannot be any solid or hard objects inside the blue circle. (Trees, stones, other fitness equipment, etc.)

Examples

1. *The two blue lines indicating the "Area of movement" are overlapping each other*

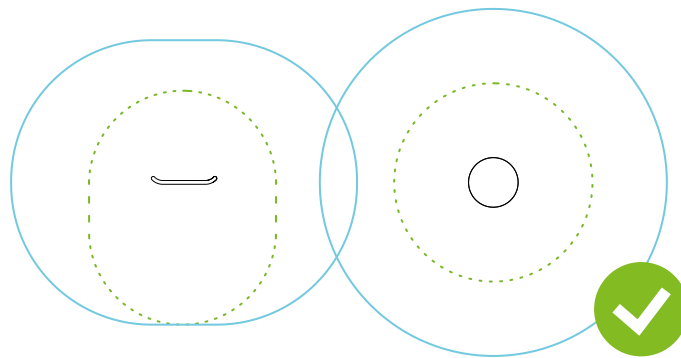

2. *The two blue lines indicating the "Area of movement" are overlapping the green line "Training Space"*

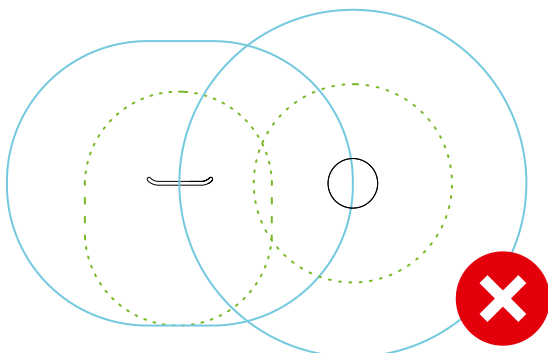
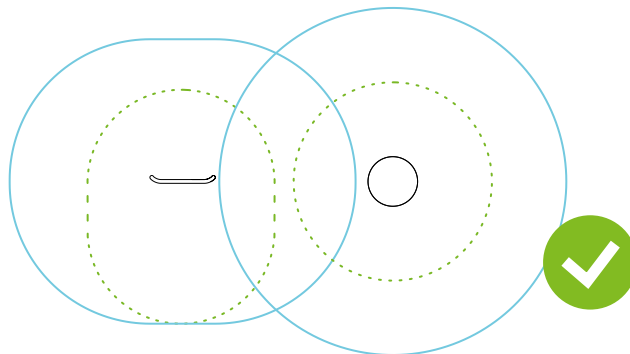

3. *The two green lines indicating the "Training Spae" are overlapping each other*

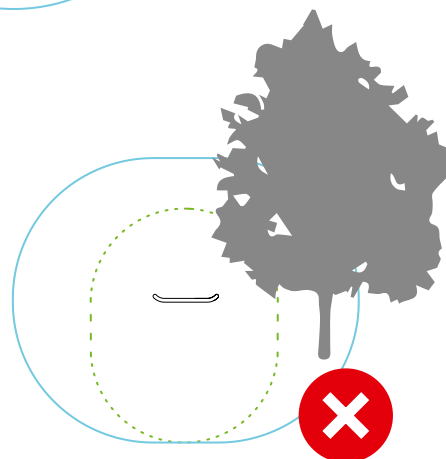

4. *A hard object, a tree, is inside the blue circle "Area of movement"*

SPIRER BATTLE ROPE - SHORT

Product no.: no-026

Measurements: L605 x W36 x H150 cm

(NB! Measured from the top of the equipment)

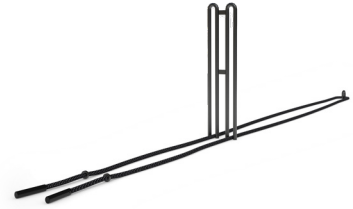

MOUNTING ACCESSORIES

2 pcs. Rope-clamps

Extra-lock glue

Glue and plugs

Product sticker

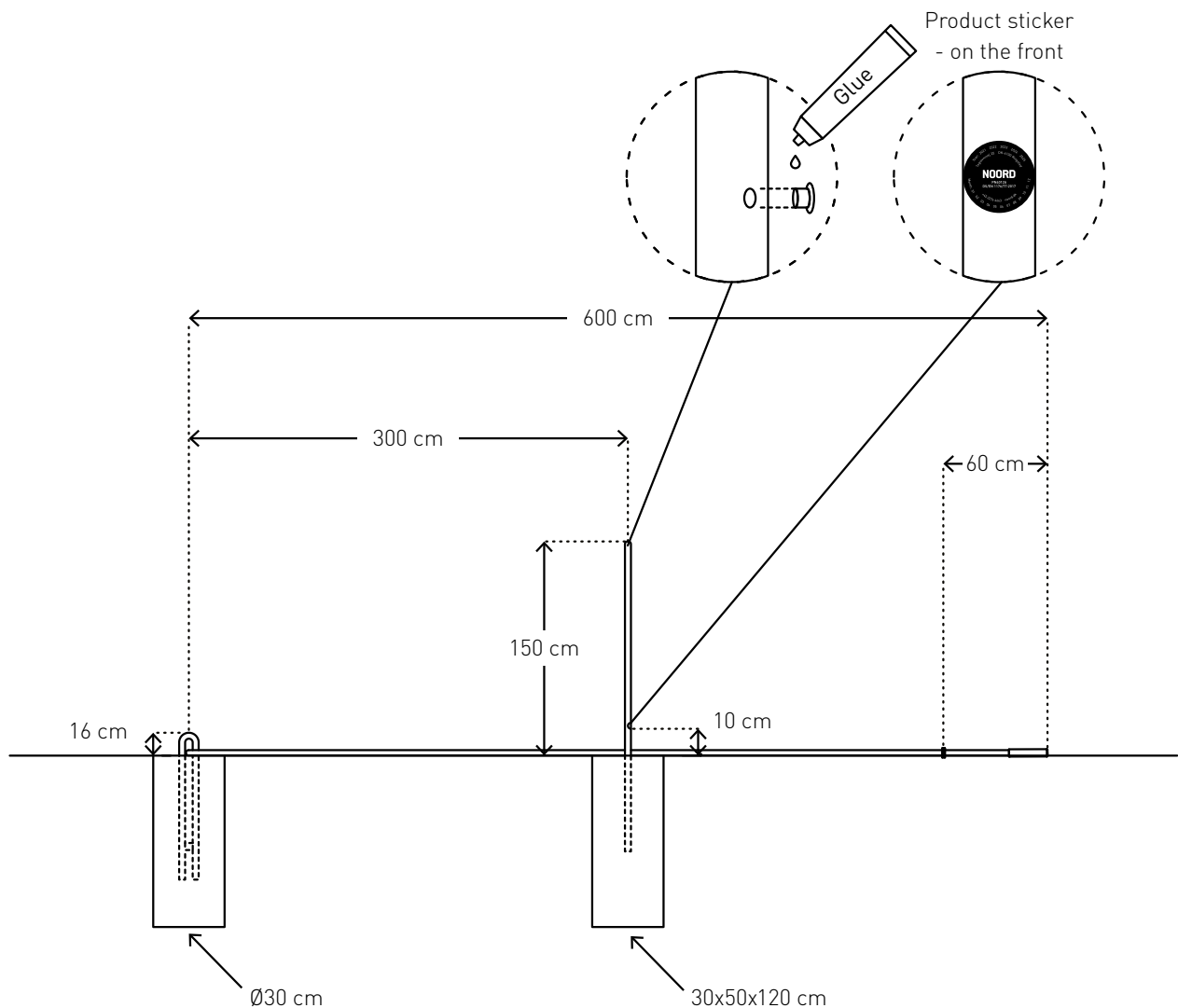

GUIDE

1. Drill holes in the dimensions indicated above
2. Fill the holes with concrete
3. Place the equipment in the holes, leveled and with the right dimensions
4. Install the ropes as illustrated on the next page
5. Fasten the rope-clamps with the dimensions indicated above. Use extra-lock glue in the screw holes
6. Glue the plugs into the holes in the equipment and place the product sticker as shown above

SPIRER BATTLE ROPE - SHORT

Product no.: no-026

Measurements: L605 x W36 x H150 cm
(NB! Measured from the top of the equipment)

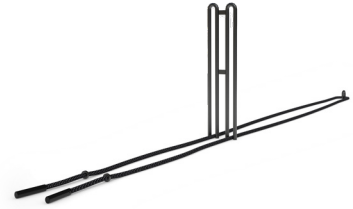

DISTANCES

Training space



Area of movement

